



Home, Garden & Lifestyle Show

Washtenaw Farm Council Grounds
5055 Ann Arbor Saline Rd., Ann Arbor, MI 48103

See Space Availability at
BRAGAnnArbor.net/HomeShow
Download the Exhibitor Info PDF.
The highlighted booths are sold.
Roll-over a booth to see the occupant.

Exhibitor Contract

2025 Booth Pricing & Reservation Form

March 15 & 16, 2025 **RENEW BY JULY 1, 2024!**

Saturday 9-6 | Sunday 10-5

If you were in the 2024 Show you have the first option on the same booth for 2025. New requests will be placed on a wait list. To renew your booth, you must return a signed copy of the contract and a non-refundable \$300 deposit by July 1, 2024. After this date, booths will be sold on a first-come, first-served basis. Balance due by January 15, 2025.

Review rules #1, #2, & #4 regarding potential fines & the set-up deadline.

Booth Size	Members	Non-Members
<input type="checkbox"/> 8' X 10'	\$895	\$1,250
<input type="checkbox"/> 10' X 10'	\$995	\$1,350
<input type="checkbox"/> 8' X 15'	\$1,195	\$1,550
<input type="checkbox"/> 9' X 15'	\$1,295	\$1,650
<input type="checkbox"/> 10' X 13'	\$1,295	\$1,650

Step 1: Reserve Space Booth # _____ (1st choice)

Booth # _____ (2nd choice) Booth # _____ (3rd choice)

Step 2: Define Electrical Needs

Do you need one outlet provided at no charge? Yes No
Additional outlets are \$15 each. An extension cord is not provided.
Total number of outlets needed: 110V _____ 220V _____

Booth Size	Location	Members	Non-Members
<input type="checkbox"/> 10' X 15'	Building D	\$1,495	\$1,850
<input type="checkbox"/> 8' X 10'	Connector	\$995	\$1,350
<input type="checkbox"/> 10' X 10'	Connector	\$1,095	\$1,450
<input type="checkbox"/> 10' X 13'	Connector	\$1,395	\$1,750
<input type="checkbox"/> 30' X 35'	Building B	\$1,995	\$2,350
<input type="checkbox"/> 28' X 56' - 68'	Building B	\$3,000	\$3,350

Step 3: Wireless Internet Wi-Fi will be charged at \$50 for the weekend. Please add Wi-Fi for \$50

Step 4: Provide Your Information Business Name _____

Contact _____ Email _____
Address _____ City _____ State _____ Zip _____
Contact Phone # _____ I have read and agree to the Show Rules and Requirements.
Signature (Required) _____

Publication information - This information will be provided to the public: Categories _____
Website _____ Phone # _____

Step 5: Reserve an ad in the Event Book Full page \$995 1/2 page \$595 1/4 page \$395 1/8 page \$295

Step 6: Send me an application for BRAG Ann Arbor Membership The 1 year membership fee is \$396

Step 7: Payment We accept checks, Visa, MasterCard, American Express and Discover.

Payment Enclosed: \$ _____ for the \$300 non-refundable deposit on 2025 space rental.
This is a non-refundable deposit and the final payment is due on or before January 15, 2025. No refunds after January 15, 2025.
 \$ _____ for the full amount of 2025 space rental.
Booth cancellations are non-refundable.
Any spaces available after January 15, 2025 require 100% payment upon reservation. Reserve your space early!

Please make checks payable to "BRAG Ann Arbor". Check Visa MasterCard American Express Discover
Card # _____ Exp. Date: ____/____/____ Security Code _____
Name as it appears on card _____ Signature _____
Billing Address _____ Billing Zip _____

Step 8: Return to: BRAG Ann Arbor
179 Little Lake Drive
Ann Arbor, MI 48103



Contact: Andrea Salemi at asalemi@BRAGAnnArbor.com
Phone: 734-996-0100
Website: www.BRAGAnnArbor.com



Home, Garden & Lifestyle Show

Washtenaw Farm Council Grounds

March 15 & 16, 2025

5055 Ann Arbor Saline Rd., Ann Arbor, MI 48103

Saturday 9-6 | Sunday 10-5

Rules & Requirements

1. Exhibitors must park in the designated Exhibitor Parking area in the three rows along the south fence during the Show hours of operation. Otherwise, your car may be towed at the owner's expense. The rows south of the building and west of the WFCG Office are for Show attendees only. Handicapped parking is along the building sidewalk and on the east side of the WFCG Office.

2. Exhibits must remain intact until the end of the Show on Sunday at 5:00pm. Anyone tearing down their display before 5:00pm may be fined \$100. This is for the appearance of the Show and the safety of the public in attendance. There will be no exceptions.

3. South entrance doors will be locked during show hours. Doors cannot be propped open during show hours. All propped doors will be secured shut. Exhibitors must use the Building G entrance during this time. Phone calls can be made at the north entrances where the public cannot enter.

4. Exhibitor agrees to install attractive display of their products and services. Exhibit materials including banners, signs, tables, chairs and products must not exceed 3' in height on the sides of the exhibit space beginning at 4' from the back of the exhibit to the front of the exhibit space. BOOTHS MUST BE SET UP AND WILL BE INSPECTED BEGINNING AT 5PM ON FRIDAY. If you exceed the height restriction you will be asked to remove or reconfigure your space. This rule helps to eliminate blocking your neighbors. In special cases, arrangements can be made in advance only if the event staff and adjoining neighbors are in agreement. NO EXCEPTIONS.

5. All TV, radio, stereo, musical instruments and other machines producing sound must be kept to a volume not to disturb neighbors.

6. Exhibitor agrees not to sublet or assign any portion of their space.

7. Management reserves the right to reject or prohibit any exhibit, part of exhibit, or proposed exhibit, including persons, things, conduct, printed materials, catalogs, or souvenirs, which in its opinion are not suitable for the show.

8. Show management assumes no responsibility for any goods or merchandise of any kind that are placed in your display. Exhibitor has sole liability for any damage or loss of any part of their display.

9. The driving of nails, tacks, screws or use of any method of attaching materials to walls, floors, railings or curtains is prohibited. Any damage caused by this will result in the exhibitor being charged for repair or replacement.

10. The exhibitor will be required to replace, repair or otherwise assume expense for any defacement or injury of premises caused by their exhibit or their representatives.

11. Heavy materials or equipment shall not be dragged, skidded or rolled over the floors, but will be transported with the appropriate equipment.

12. Exhibitor is responsible for any stains, scratches, marks or mars left on floor.

13. No highly flammable or explosive materials will be permitted in the buildings.

14. No open flames are permitted within the buildings except by management's consent.

15. No liquor, intoxicating beverages or smoking will be permitted in the buildings at any time during the exposition.

16. No helium balloons or yardsticks may be given out at the Show.

17. It is understood and agreed that in case the management shall fail to open the show as scheduled, or to furnish space that the exhibitor contracted (or to substitute a comparable space), it will refund to the exhibitor all sums paid. However, if management is unable to open the Show, or is compelled to postpone or relocate the Show due to strikes, fires, casualties, acts of God, or other causes beyond management's control, then it shall not be in any manner financially liable to exhibitor.

18. Management reserves the right to adopt and set further rules and regulations as shall be reasonably necessary for the convenience and safety of exhibitors.

19. The management reserves the right to move an exhibitor to an equal space if their space should block the sale of multiple spaces to another exhibitor(s).

20. Exhibitor agrees to observe designated hours of the show.

21. Uniform set-up furnished by the management includes electrical outlets, lights and power service, janitor service (aisles only) and general lighting, all within the limits of the facilities of the Washtenaw Farm Council Grounds.

22. Company vehicles may be parked inside the west-facing fence by the road. Banners may be hung on the fence during the Show.

23. No dogs except certified service dogs are permitted.



BRAG Ann Arbor
179 Little Lake Drive
Ann Arbor, MI 48103

Phone: 734-996-0100 |
Contact: Andrea Salemi at asalemi@BRAGAnnArbor.com
Website: www.BRAGAnnArbor.com

Please select the categories that best describes what you would like the public to associate your company with. Write the category you select in the blank under Step 4 on the contract on the previous page and send it in to reserve your space.

AIR DUCT CLEANING
APPLIANCES
ASPHALT PAVING & SEALCOATING
AWNINGS
BANKS/FINANCING
BASEMENT WATERPROOFING
BRICK, STONE & MASONRY SUPPLIERS
BUILDERS & REMODELERS
BUILDING MATERIALS
CARPET & FLOOR COVERING
CERAMIC TILE & MARBLE SUPPLIERS
CHIROPRACTIC SERVICES
CLEANING SERVICES
COMPUTER & TECH CONSULTANTS
CONCRETE CLEANING & SEALING SERVICES
CONCRETE PAVERS & BLOCK RETAINING WALLS
COUNTERTOPS
DECKS & PATIOS
DECORATIVE CURBS
ELECTRICAL CONTRACTORS
EXCAVATING
FENCE DESIGN & INSTALLATION
FINANCIAL PLANNING
FIRE SAFETY & CARBON MONOXIDE
FIREPLACE: INSTALLATION, ENCLOSURES & REPAIRS
FOOD: CONCESSIONS/ONLINE SALES
FURNITURE
GARAGE DOORS
GARDEN DECORATIONS
GENERATORS
GUTTER PROTECTION SYSTEMS
HARDWARE: DECORATIVE INTERIOR & EXTERI
HARDWOOD FLOOR REFINISHING
HARDWOOD FLOORING
HEALTH & BEAUTY
HEATING & AIR CONDITIONING CONTRACTORS
HOME IMPROVEMENT, MAINTENANCE & REPAIR
HOME THEATER
INSULATION: CONTRACTORS & SUPPLIERS
INSURANCE
KITCHEN & BATH CABINETRY
KITCHEN & BATH REMODELING
LANDSCAPING DESIGN, LAWN SERVICE, SUPPLY
LAWN & GARDEN EQUIPMENT
LIGHTING FIXTURES
LIVESTOCK COOPS / CONTAINMENT
LUMBER & MILLWORKS
MATTRESSES & ADJUSTABLE BASES
MOLD REMOVAL
MORTGAGE LENDERS
NON-PROFIT ORGANIZATIONS
PAINTING, DECORATING & WALLCOVERING CONTRACTORS
PAINTING, DECORATING & WALLCOVERING SUPPLIERS
PEST CONTROL
PLUMBING SERVICES
POWER WASHING
REAL ESTATE
RENTAL EQUIPMENT
ROOF CLEANING SERVICES
ROOFING & SIDING CONTRACTORS
SCREENS
SECURITY SYSTEMS
SEPTIC SEWER/TANK INSTALLATION,
CLEANING, REPAIRS & SERVICE
SOLAR & ALTERNATIVE POWER
TIMBER FRAMING
TREE SERVICES
UTILITIES
WATER DAMAGE RESTORATION
WATER SOFTENERS & PURIFICATION SYSTEMS
WINDOW & DOOR: INSTALLATION,
SUPPLIERS, TINTING & REPAIR
WINDOW CLEANING
WINDOW TREATMENTS: BLINDS & DRAPERIES

Building

G

Connectors
Ceiling 8' high

DOOR

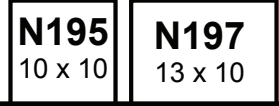
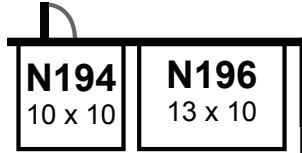

DOOR

Connectors
Ceiling 8' high

G198
10 x 10

G199
10 x 10

G200
10 x 10

G201
10 x 10

G202
10 x 10

**TICKETS
& INFO**

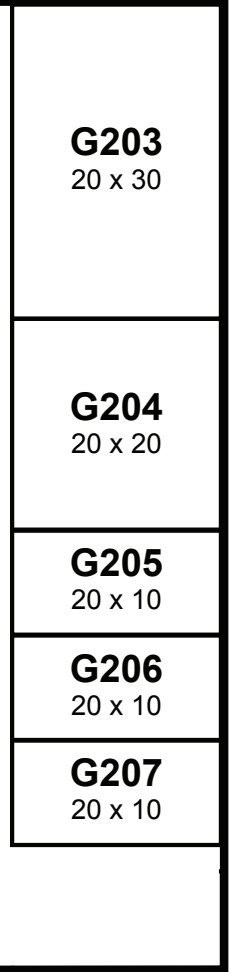

Entrance

**Home, Garden
& Lifestyle Show**



Building F



LANDSCAPING

GARDENS

FOUNTAINS

CUSTOM SIZED SPACES AVAILABLE

Dirt Floor - Suitable for Pavers

PONDS

BACKYARDS

TREES

LAWNS



Connectors
Ceiling 8' high

DOOR

N190
10 x 10

N192
13 x 10

N191
10 x 10

N193
13 x 10

DOOR

Connectors
Ceiling 8' high

Home, Garden & Lifestyle Show

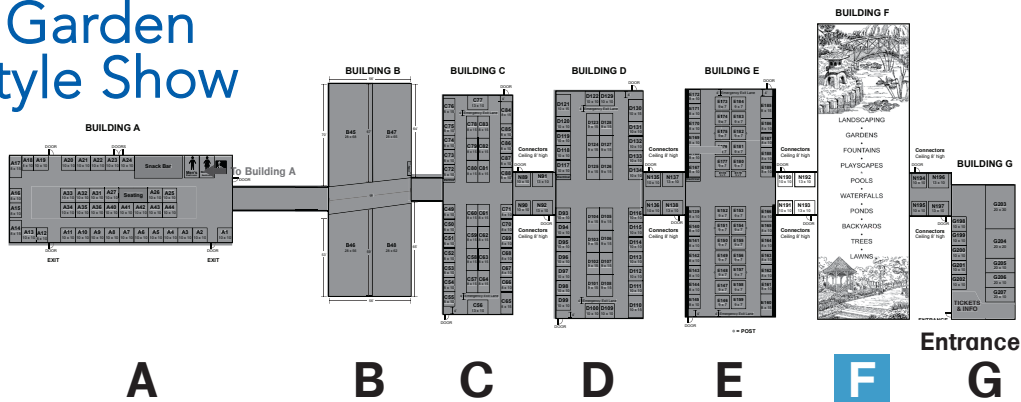

Building

E

Connectors
Ceiling 8' high

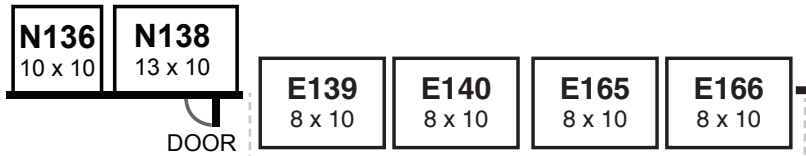
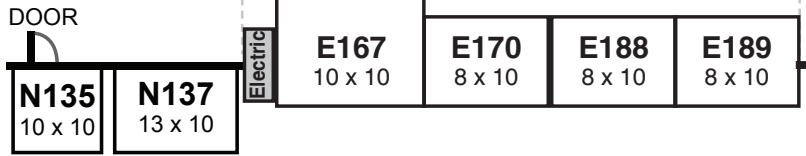

Connectors
Ceiling 8' high

Home, Garden & Lifestyle Show

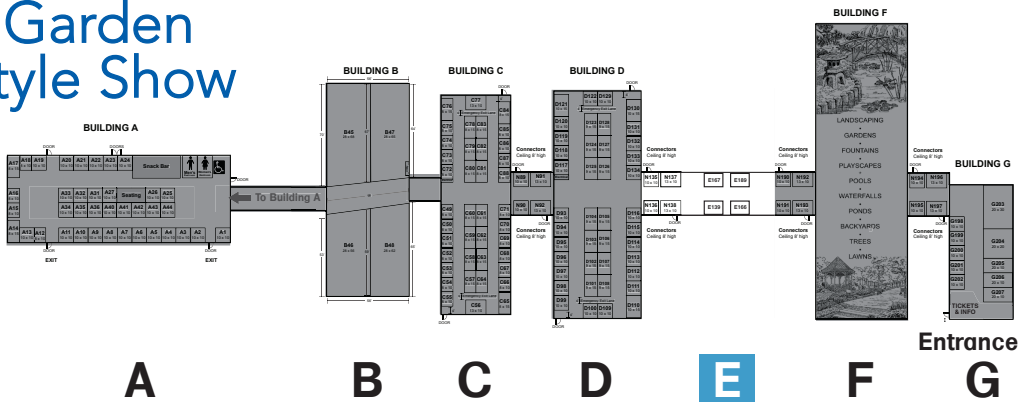

Building

D

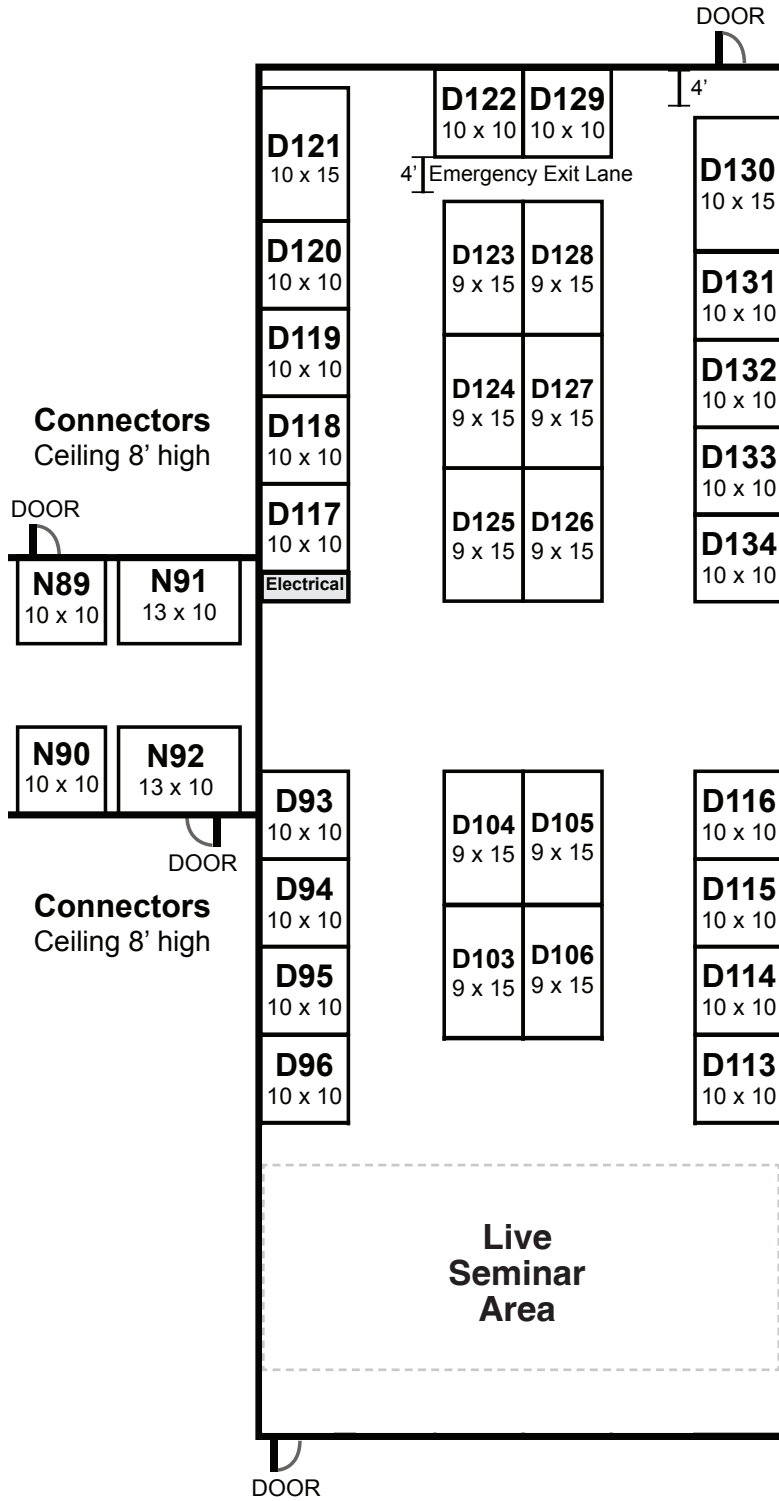

Home, Garden & Lifestyle Show

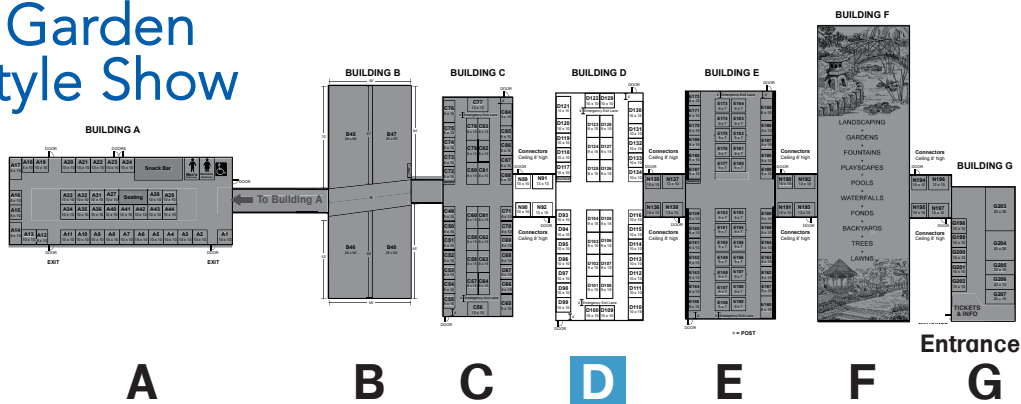

Building

C

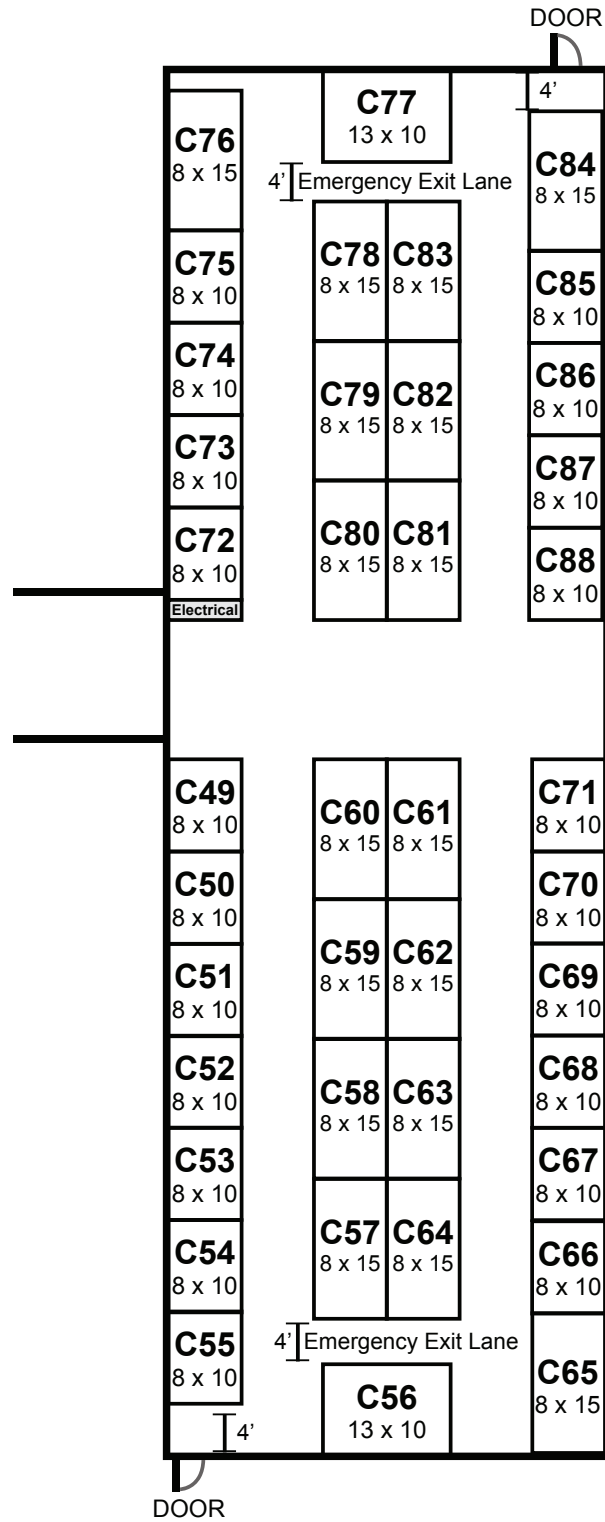

Home, Garden & Lifestyle Show

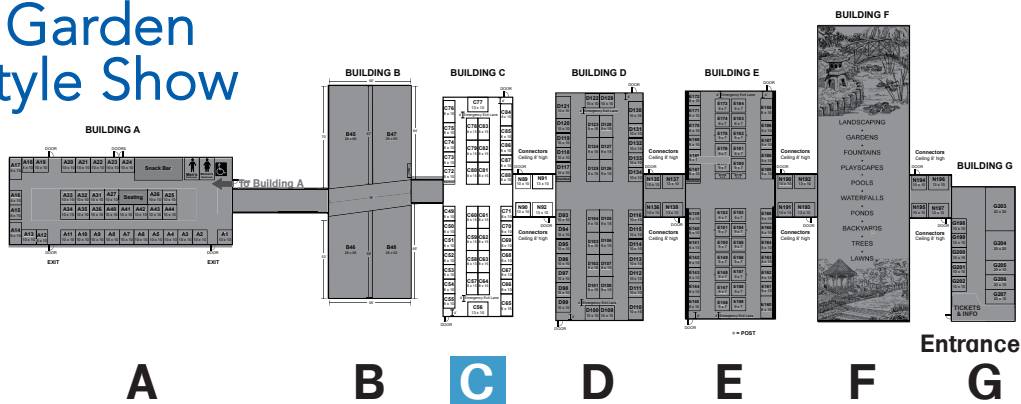

Building B

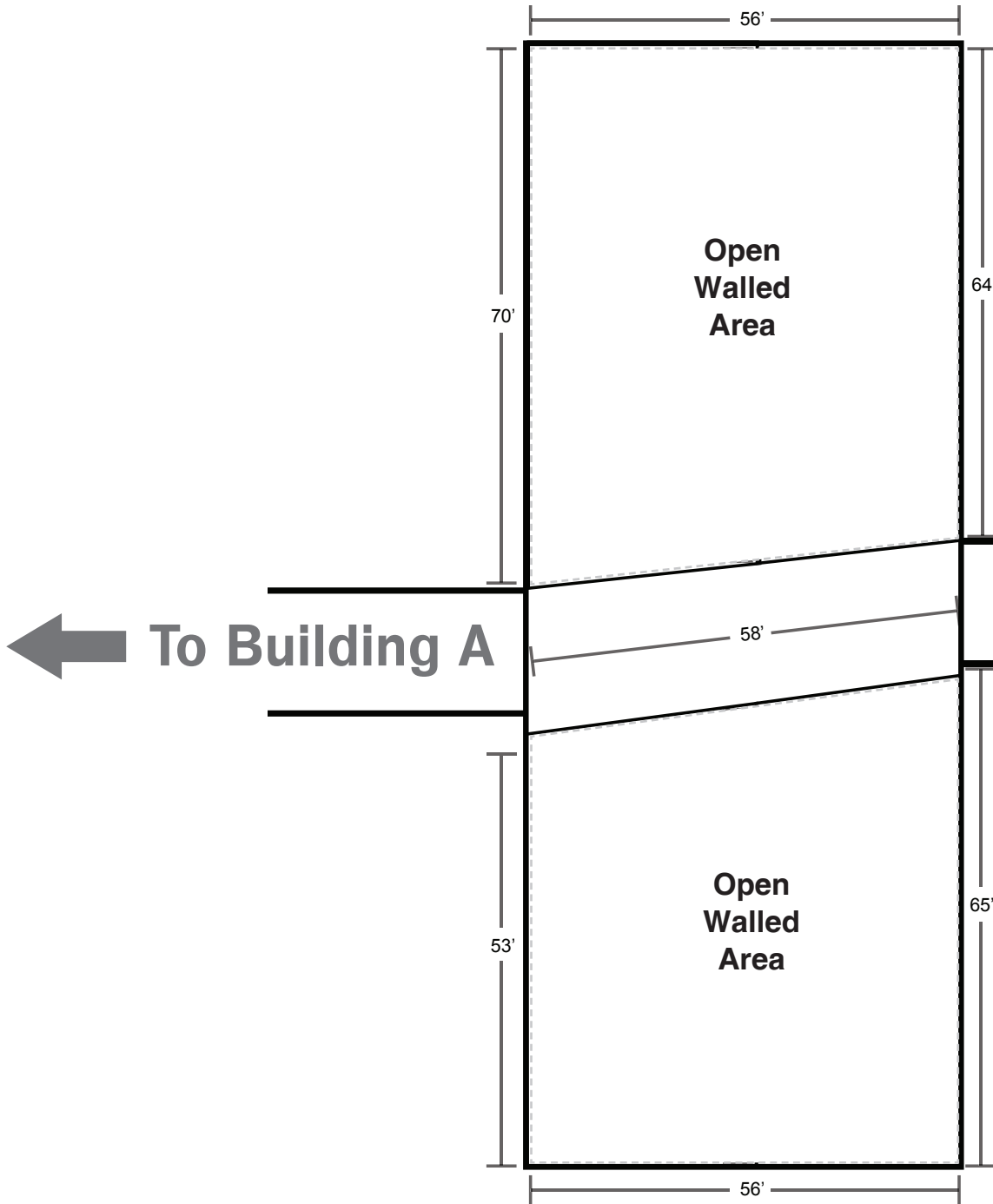

Home, Garden & Lifestyle Show



Building

A

BUILDING A

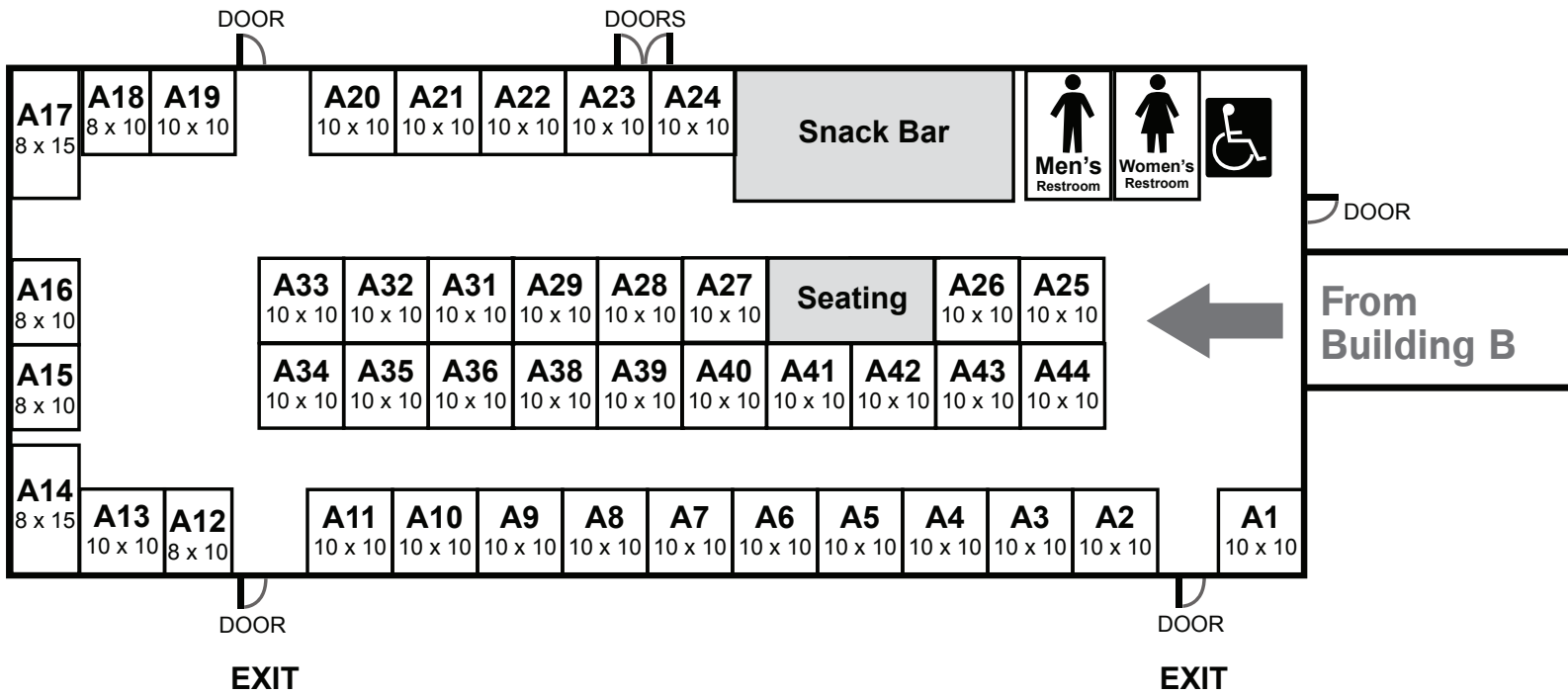

Home, Garden & Lifestyle Show

